

Hanli refrigeration

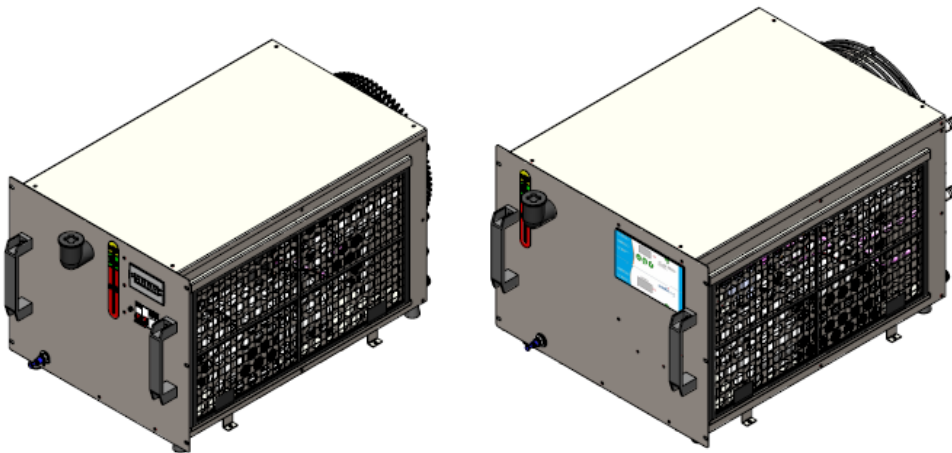

- **HL-1000/1500/2000/3000/4000/6000/8000/12000/15000 /20000/30000 Series**
- **SCH-1000/1500/2000 Series**

## User's Manual of Fiber Laser Chiller

**WUHAN HANLI REFRIGERATION TECHNOLOGY CO., LTD.**

Add: NO.168, Tongjiang 1<sup>st</sup> Road, Hannan District, Wuhan, China.

Post Code: 430090 Email: hanli-laserchiller@hanlizl.com

Tel: +86-13628622086

website : [www.hanlizl.com](http://www.hanlizl.com)



## Catalogue

Introduction -----	4
Warning notices-----	5
1 summarize-----	8
2 service conditions -----	8
2.1 environmental requirement -----	8
2.2 Medium requirements-----	9
3 Model Coding -----	10
4 performance parameter -----	10
5 Shape and component name-----	11
6 Installation-----	11
6.1 Installation conditions and requirements-----	11
6.2 Water connection -----	13
6.3electrical connection -----	14
6.4 Add water and exhaust-----	14
6.4.1 add water -----	14
6.4.2 Exhaust and drain-----	14
6.5 warm prompt -----	15
7 Product usage -----	15
7.1Check before commissioning-----	15
7.2 Introduction of controller panel-----	15
7.2.1 Introduction of An integrated controller panel -----	16
7.2.2 Split controller panel introduction -----	17
7.3 starting up display -----	17
7.4 temperature display -----	17
7.4.1 Integrated controller temperature display -----	17
7.4.2 Separate controller temperature display -----	18
7.5 parameter setting -----	18
7.5.1 Integrated controller parameter setting -----	18
7.5.2 Split controller parameter setting -----	18
8 maintaining -----	19

---

8.1 Summer dust -----	19
8.2 Winter antifreeze -----	19
8.3 current maintenance -----	20
9 Failure analysis and elimination-----	21
10 circuit diagram-----	22
11 Transportation and storage-----	24
11.1 transportation requirement-----	24
11.2 Storage requirements-----	24
12 other description-----	25
12.1 service support -----	25
12.1.1 warranty coverage -----	25
12.1.2 Outside the scope of the warranty -----	25
12.2 any other business -----	25











## foreword

Thank you for your trust in our company and choose to use our fiber laser chillers. In order to enable you to better understand and use our products, make them play the best results, and provide you with complete after-sales service, please contact us. Read this manual carefully before use, and you can refer to this manual if you have any doubts in the process of using the product.

This manual is prepared for the owners and users of the chiller. It includes product performance parameters, appearance and component names, working principles, daily maintenance, fault descriptions and troubleshooting methods, etc., for installation, operation, debugging and maintenance. This manual is not a quality guarantee. Corrections to printing, modification of product information, and product improvement are all explained by our company without prior notice. The updated content will be incorporated into the reprinted manual. If you have any questions about the use of the product or suggestions for improvement, please contact us.

# Warning notices







In order to ensure your personal safety and avoid property damage, you must pay attention to the warnings in the instructions of our company. The warnings are listed below according to the level of danger, but not limited to the following list. General knowledge of electricity use and safety regulations should also be followed.

 <b>Danger</b> Be sure to take safety precautions, otherwise it will cause death or serious bodily injury		
Prompt project	Reminder mark	operation specification
Please be operated by professional technicians	 必须执行	Handling, installation, piping, electrical, operation, maintenance, overhaul and other operations must be carried out by professional personnel
High Voltage Risk		Contact with electrical parts can cause serious personal injury or death
scald burn risk		Any part of the body and heat-resistant items must be kept away from the high temperature area, otherwise it will cause personal injury or property damage
electrical connection	 必须执行   必须执行	a) The power supply system must be selected in accordance with the relevant content of the nameplate or manual; b) The cable must use a standard cable, and the wire diameter is selected according to the standard; c) The grounding must be installed and the connection must be reliable, otherwise it will cause the danger of electric shock or fire
maintenance	 必须执行	You must cut off the power for 3 minutes before starting the operation.
Scrapping		When the equipment reaches the service life and needs to be scrapped, it must be disposed of with industrial waste, and it must be scrapped with the guidance of professional personnel.
Do not use beyond the scope of the specification	 禁止	It is forbidden to use the equipment beyond the specifications in order to avoid serious accidents such as equipment breakage, injury, fire and electric shock.
Can not be used in explosive environment	 禁止	Do not install in dangerous places with flammable gas
The equipment shall not be operated without a cover	 禁止	There are electrical parts in the machine . It is forbidden to run without a cover. There is danger of electric shock.



Water proof	 禁止	Do not let the equipment water, water, or there may be a short circuit and electric shock risk.
-------------	---	---









**Alarm** Be sure to take safety precautions, otherwise it will cause death or serious bodily injury



Prompt project	Reminder mark	operation specification
Transportation and installation	 必须执行	During the transportation and installation of the equipment, the equipment must be firmly fixed, otherwise there is a risk of overturning and falling
electric protection	 必须执行  必须执行	The access end of the power cable must match the leakage and overload protection devices according to the rated current marked on the nameplate of the equipment.
Stop the operation immediately in case of abnormality	 必须执行	When the equipment is abnormal, as long as the reason is not clear, do not start, otherwise there will be damage, electric shock, fire, injury risk.
Fingers and foreign bodies should not be inserted into the equipment gaps	 禁止	There are rotating parts installed in the equipment. When the equipment is running, it is forbidden to put fingers or foreign bodies into the gaps of the equipment, otherwise it will cause personal injury.
Refrigerant leakage	 必须执行	a) When the refrigerant leaks, be sure to ventilate and ventilate, otherwise when the refrigerant fills the enclosed space in large quantities, it may cause anesthesia and suffocation to the human body; b) Avoid contact with skin, otherwise it will cause frostbite.

 Note Please take safety measures, otherwise it may cause minor personal injury and property damage

Prompt project	reminder mark	operation specification
Do not transport with liquid	 禁止	The equipment is forbidden to be transported with liquid to prevent leakage of internal pipelines.
Carry	 必须执行	a) The equipment should be fixed before transportation to prevent the equipment from moving due to vibration and external forces. If there is excessive vibration and external force, the internal equipment may be damaged; b) The inclination angle is $\leq 45^\circ$ , otherwise the refrigeration system will fail.

<p>operating environment</p>	 禁止	<p>a) It is forbidden to use it in special environments such as high temperature, humidity, and strong electromagnetic interference;                  b) The equipment must be installed in a place where there is no direct sunlight and away from fire sources.</p>
<p>installation</p>	 必须执行	<p>a) The equipment must be installed horizontally, otherwise the refrigeration system will fail; b) It is forbidden to place objects within 1.5 meters around the air inlet and 2.0 meters around the air outlet. If the suction and exhaust air is hindered, the cooling capacity that the equipment should have cannot be used.</p>
<p>Before the test run</p>	 必须执行	<p>a) Make sure that the water supply pipe on the equipment side is not blocked;                  b) It is necessary to check the water pipe and the water pump to confirm that a proper amount of water enters the water pump and exhaust the air through the water exhaust valve otherwise the water pump will be damaged                  c) Confirm that the state of the equipment is normal and safe, otherwise it may cause injury and damage.</p>
<p>No trampling on the equipment</p>	 禁止	<p>Please do not board the device or sit on it, otherwise it may cause injury accidents such as falling or overturning.</p>
<p>Clean the air filter regularly</p>	 必须执行	<p>Clean the air filter at least once a week. If the air filter is blocked, the cooling capacity will decrease, the power consumption will increase, and the alarm will not work properly.</p>
<p>Equipment surface cleaning</p>	 必须执行	<p>a) Please use cleaning agents that are non-corrosive to metals and plastics;                  b) After cleaning, please keep the cleaning agent properly to prevent the liquid from leaking anywhere in the equipment;                  c) The container for storing the cleaning agent must be completely sealed to avoid danger.</p>
<p>Protective gloves should be worn when maintenance, overhaul and cleaning</p>	 必须执行	<p>a) The sharp edges of the condenser fins may cut the skin;                  b) The temperature of the internal compressor and refrigerant piping is very high, and direct skin contact may cause burns.</p>
<p>anti freezing</p>	 必须执行	<p>When the ambient temperature is lower than 0°C and the machine is shut down for a long time, it is necessary to drain the liquid and blow the water in the system with compressed air, otherwise there is a danger of freezing and cracking the components and pipelines.</p>

## 1 summarize

This product is a cooling device designed and manufactured for laser cutting, laser welding, laser engraving, laser marking, laser printing and other laser processing equipment. It can provide two cooling media with stable temperature for the above application scenarios, one is low temperature The cooling liquid cools the fiber laser, and the other is room temperature cooling liquid, which cools the fiber laser cutting head.

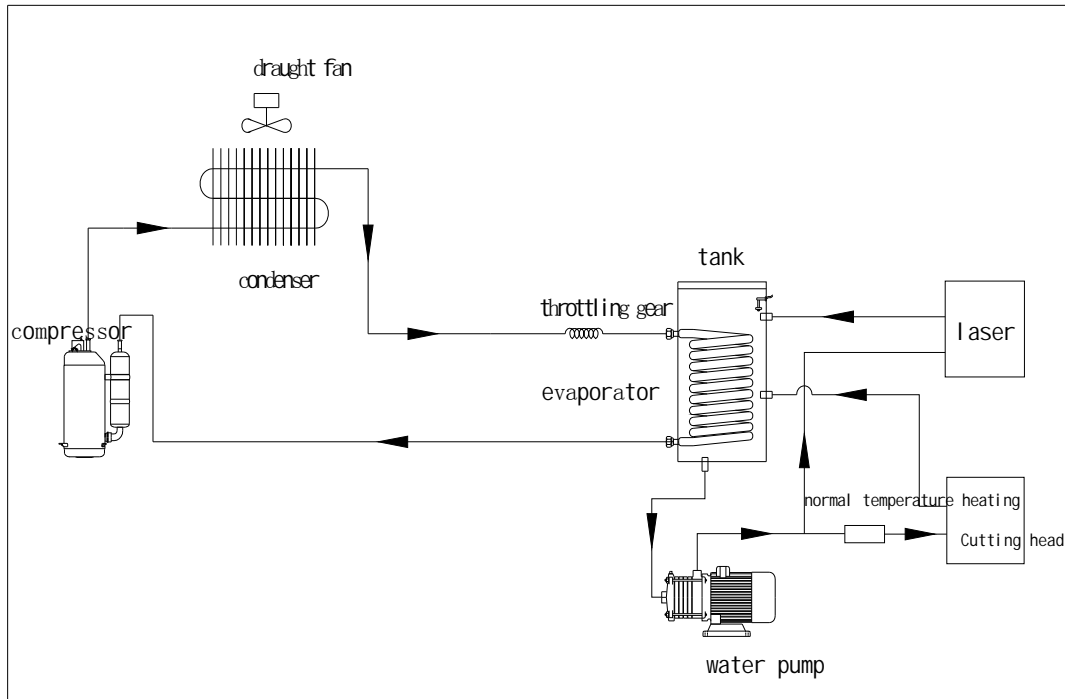

Fig. 1 Composition and working principle of the chiller system

The chiller is composed of a compressor, a condenser, a throttling device, an evaporator, a water tank, and a water pump. Its working principle is that the compressor compresses the superheated vapor sucked from the evaporator into high-temperature and high-pressure gas, and discharges it to the condensation. The condenser releases heat into a high-pressure liquid, which is reduced by the throttling device and becomes a low-temperature and low-pressure subcooled liquid. The low-temperature and low-pressure subcooled liquid is vaporized by the evaporator to absorb heat into superheated steam, and then returns to the compressor to enter the next cycle. Refrigeration function. The heat absorbed by the vaporization of the evaporator comes from the cooling medium, and the temperature of the cooling medium will be lowered. The low-temperature cooling liquid is divided into two by the water pump and pressed out. One low-temperature cooling liquid is used to cool the laser, and the other is heated by a heating device to a normal temperature cooling liquid for the laser. The cutting head cools down.

## 2 service conditions

### 2.1 environmental requirement

- environment temperature: 0~45°C;



- relative humidity:  $\leq 90\%$ ;
- elevation :  $\leq 3000\text{m}$ ;
- The relationship between the cooling medium temperature and the ambient temperature is shown in Fig.2

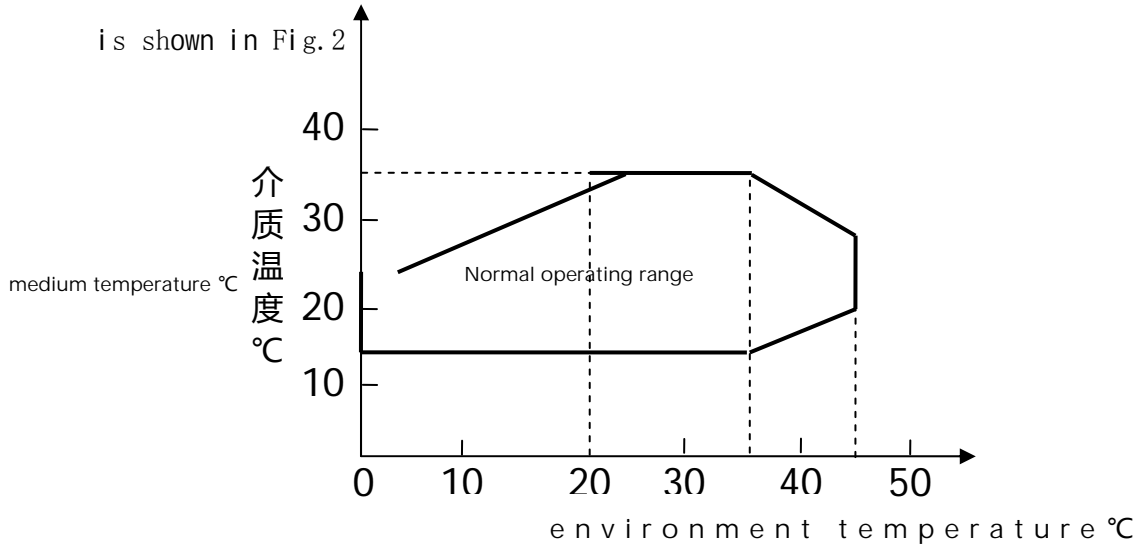

( a ) Pure softening water operating range

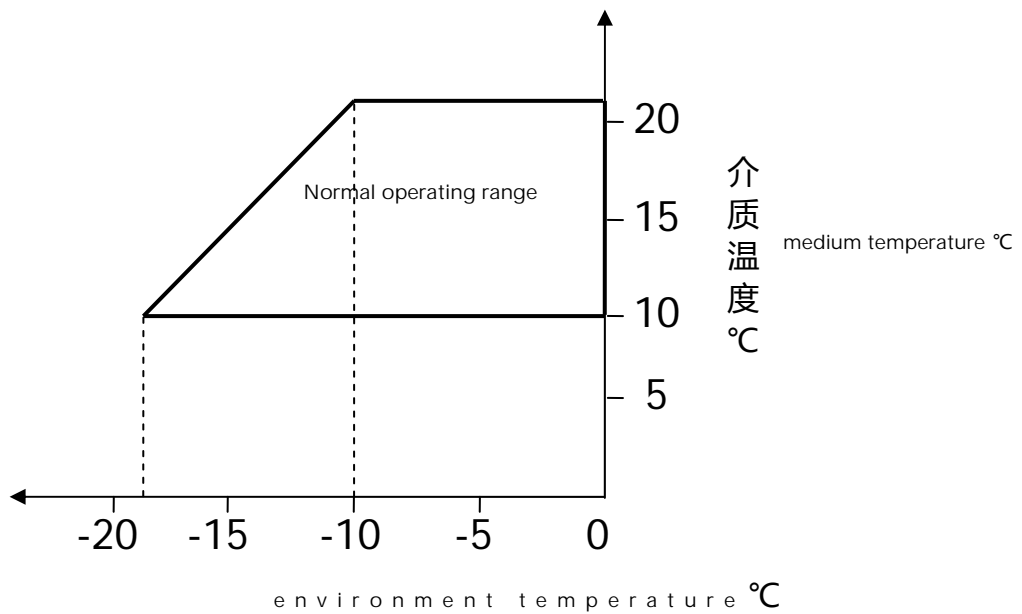

( b ) Add antifreeze running range

Figure 2 Operating range of equipment

Note: the above operating range is obtained in the laboratory according to standard product testing, for reference, the operating range of each specific model may be slightly different, please contact the manufacturer for details.

## 2.2 Medium requirements

The cooling medium must be softened water, such as purified water, distilled water, high purity water, etc., ethylene glycol with volume ratio of less than 30% is allowed, or ethanol with volume ratio of less than 20% is allowed, preservatives and sterilizers approved by the manufacturer are allowed to be added.

It is strictly prohibited to use antifreeze with a volume ratio > 30%, oil and oil-based liquids, flammable and explosive liquids, liquids with solid particles, and liquids that are corrosive to aluminum and stainless steel are strictly prohibited.

### 3 Model Coding

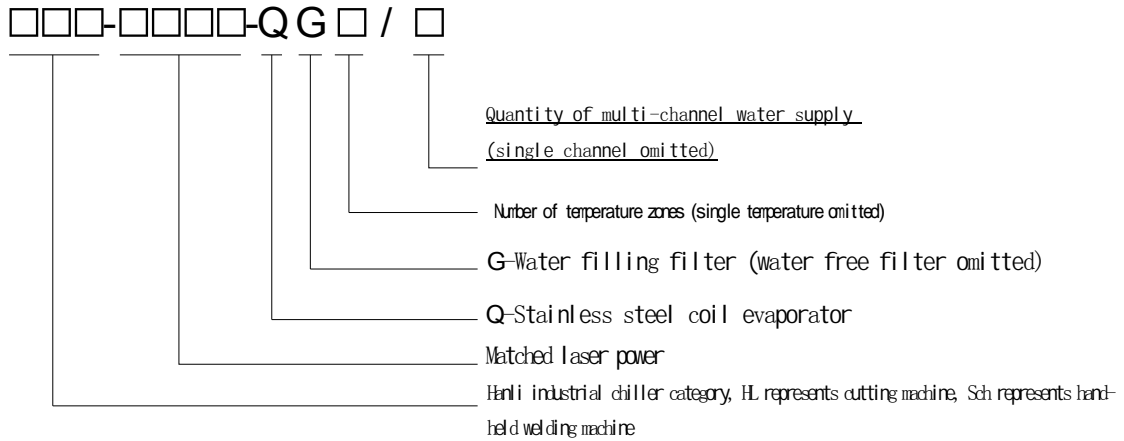

For example: HL-3000-QG2/2 means a laser cutting machine with a matching laser power of 3000W, using a stainless steel coil evaporator, a filter installed in the water circuit, and dual temperature two-way water supply.

For example: SCH-1500 means a handheld welding chiller with a matching laser power of 1500W, a water filter is installed by default, and two-channel water supply with dual temperature.

Note: This model description is the company's standard product code description, and does not list all models. Please confirm with our company before ordering the specific model. If there is any change, we will not notify you.

### 4 performance parameter

Serial number	Model	voltage	power (kW)	refrigerant	Note amount of Fluorine (kg)	head of delivery (m)	Flow (m <sup>3</sup> /h)	weight (kg)	dimension (mm)	water capacity (L)
1	HL-1000-QG2/2	220V 50Hz	2.0	R410A	0.45	38.5	2	60	600×500×840	13
2	HL-1500-QG2/2	220V 50Hz	2.7	R410A	0.50	47.5	2	63	610×500×890	13
3	HL-2000-QG2/2	220V 50Hz	3.3	R410A	0.70	47.5	2	75	660×540×970	19
4	HL-3000-QG2/2	220V 50Hz	3.9	R410A	1.00	48.5	4	90	760×560×1050	40
5	HL-4000-QG2/2	220V 50Hz	5.0	R410A	1.30	58.5	4	100	810×610×1150	40

6	HL-6000-QG2/2	380V 50Hz	8.4	R410A	1.80	58.5	4	130	820×700×1410	54
7	HL-8000-QG2/2	380V 50Hz	12.5	R410A	3.70	68	8	210	1000×800×1460	105
8	HL-12000-QG2/2	380V 50Hz	17.0	R410A	2.1*2	68.0	8	280	1380×860×1355	175
9	HL-15000-QG2/2	380V 50Hz	19.0	R410A	2.4×2	68.0	8	310	1400×800×1460	160
10	SCH-1500	220V 50Hz	1.7	R410A	0.38	38.5	2	50	800×490×430	16
11	HL-20000-QG2/2	380V 50Hz	26.0	R410A	4.1×2	50	12	400	1980×900×1270	300

Note: the above table is part of the standard product performance parameters, for reference only, if there is change without notice.

## 5 Shape and component name

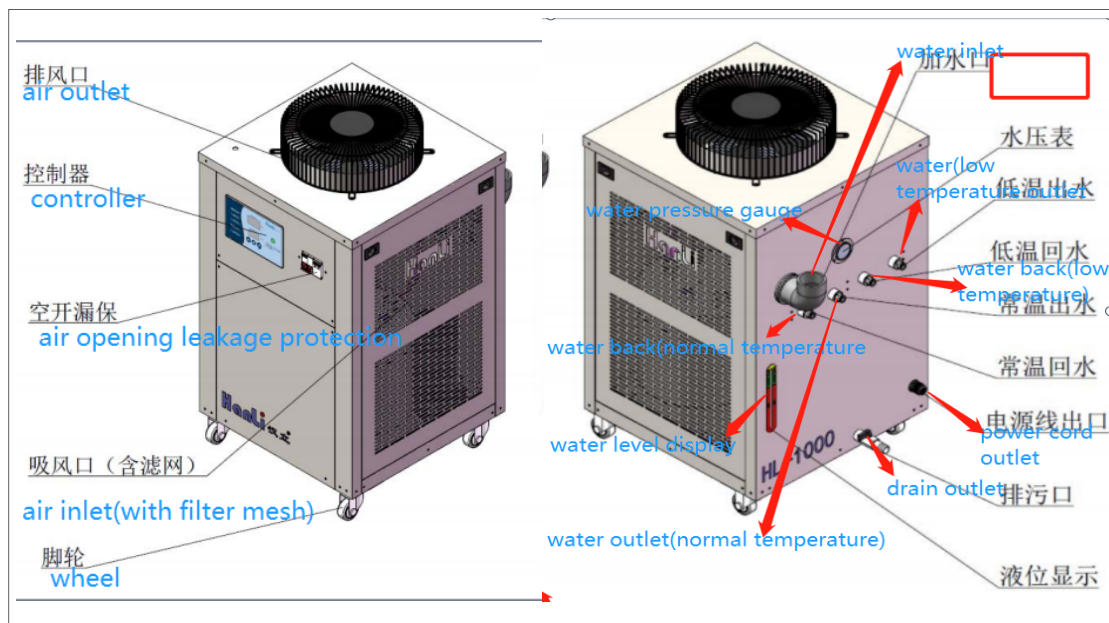

Note: The above appearance and component names are only one of the models, and the appearance and component names of different models will be slightly different.

## 6 Installation

### 6.1 Installation conditions and requirements

- Open the package and first check whether the equipment is in good condition and the list of accessories is complete.

- It must be installed horizontally and cannot be tilted. As shown in Figure 3, anchor bolts should be used for equipment without casters, and the universal wheels should be locked for equipment with casters.
- There should be no obstructions within 1.5m of the air inlet and 2.0m of the exhaust, so as not to affect the heat dissipation of the equipment, as shown in Figure 4.
- The product must not be installed in harsh environments such as corrosive, flammable gas, heavy dust, oil mist, metal and other conductive dust, high temperature and humidity, strong magnetic field, direct sunlight, etc., as shown in Figure 5.

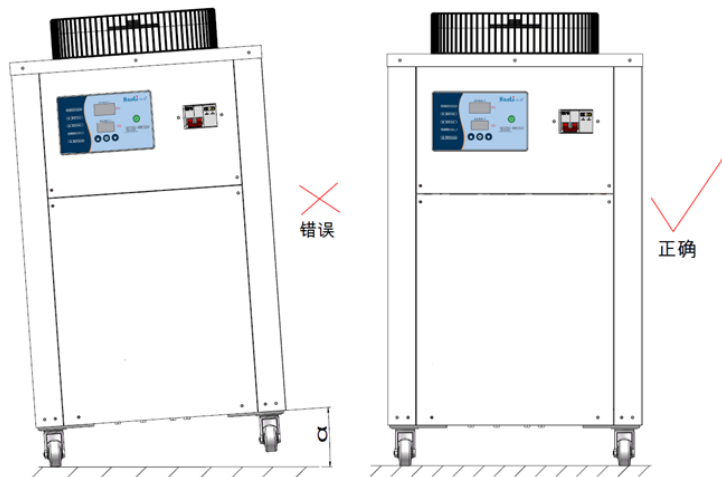

Fig3 Requirements for equipment installation form

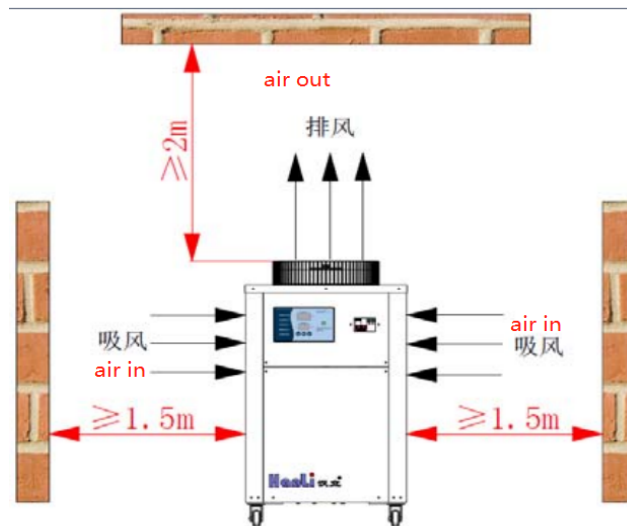

Figure 4 Equipment installation space requirements

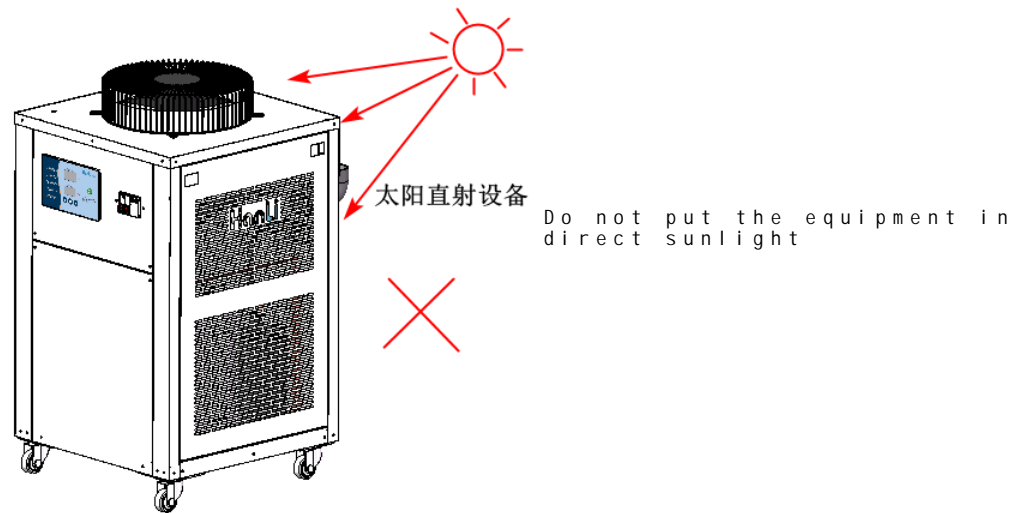

Fig5 Equipment installation environment requirements

## 6.2 Water connection

- According to the equipment inlet and outlet mark to determine the pipeline layout direction, in case the equipment can not operate normally.
- Pipeline internal construction needs to be cleaned up, strictly avoid impurities, once the system into the impurities, easy to reduce the refrigeration capacity, and may cause the failure of the pump or refrigeration system.
- Pipeline connection: the connection method of the chiller and the laser, as shown in Figure 6, the inner diameter of the pipe should not be smaller than the diameter of the water inlet and outlet of the chiller. If the inner diameter of the pipe is smaller than the requirement, the chiller manufacturer must agree.
- Pipeline resistance: The distance between the connecting pipelines between equipment should be the shortest to avoid right angles and bends, and the total pressure drop should be  $\leq 0.05\text{MPa}$ . If metal pipes are used, insulation measures should be taken to prevent energy loss. The pressure of the pipeline must reach 1.5 times of the water supply pressure of the pump

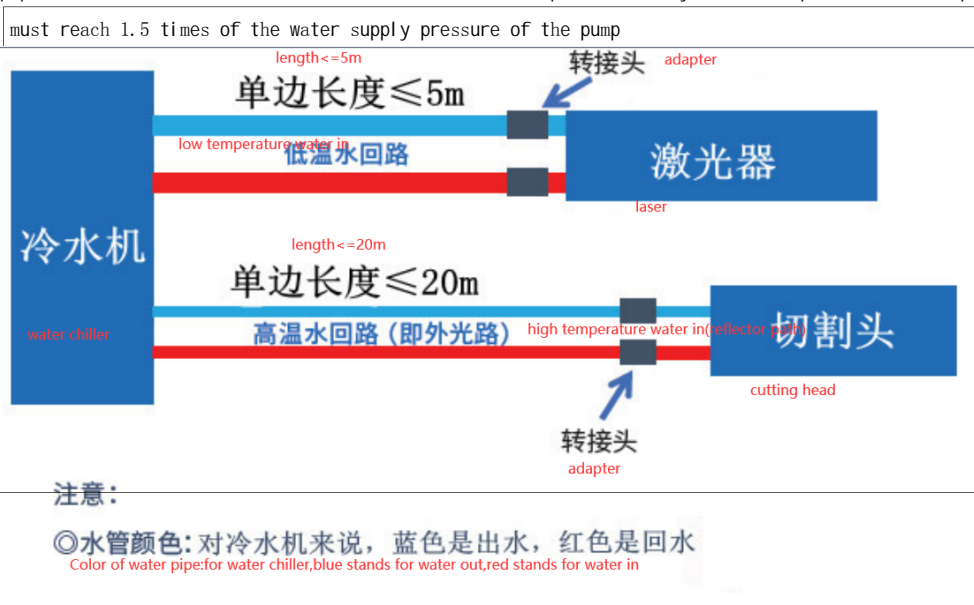

Fig6 Schematic diagram of connection between chiller and laser

## 6.3 electrical connection

1. Please refer to the wiring mark of the chiller when wiring.
2. Recommended reference standards for power cord diameter selection

Rated current / A	≤5	≤10	≤15	≤25	≤35	≤50
Power cable diameter (copper wire) / mm <sup>2</sup>	1.0	1.5	2.5	4.0	6.0	10.0

- ★ This data is provided according to the IEC 60204-1 standard and is for reference only.
  - ★ The power cord must use a standard cable
  - ★ Refer to the nameplate of the chiller for the rated power
3. The main circuit of the power supply must be equipped with appropriate leakage and overload protection devices, and the chiller must be well grounded
  4. The power supply voltage is allowed to fluctuate less than ±10%, the frequency fluctuation is less than ±1Hz, and it is far away from electromagnetic interference sources.
  5. Connection of signal terminals: The output is the passive dry node signal of flow alarm and over-temperature alarm

## 6.4 add water and air out

### 6.4.1 add water

Add softened water to the liquid level standard area (green area) through the water inlet of the equipment, as shown in Figure 7.

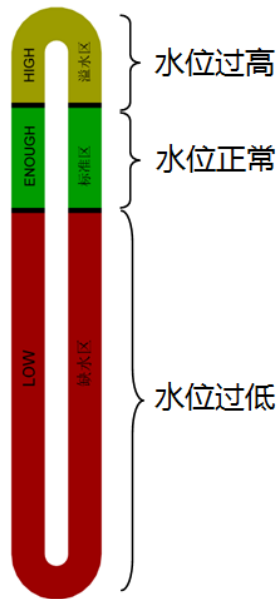

Fig. 7 Liquid level identification

### 6.4.2 air out and drain out

After adding water for the first time and replacing with new water, exhaust the air in the water pump to start use, otherwise the equipment will be damaged

For the exhaust method, slowly loosen the exhaust screw plug of the water pump (do not unscrew), and air is discharged until water flows out, and then tighten the exhaust screw plug (see Figure 8, only the vertical type is shown in the figure) The exhaust position of the pump and the horizontal pump is shown. According to customer requirements and specific models, the pump will be different, and the exhaust position will also be different. For details, see the external prompt mark of the pump) Note: When you need to drain the liquid in the equipment in winter, loosen the drain plug below to drain the liquid.

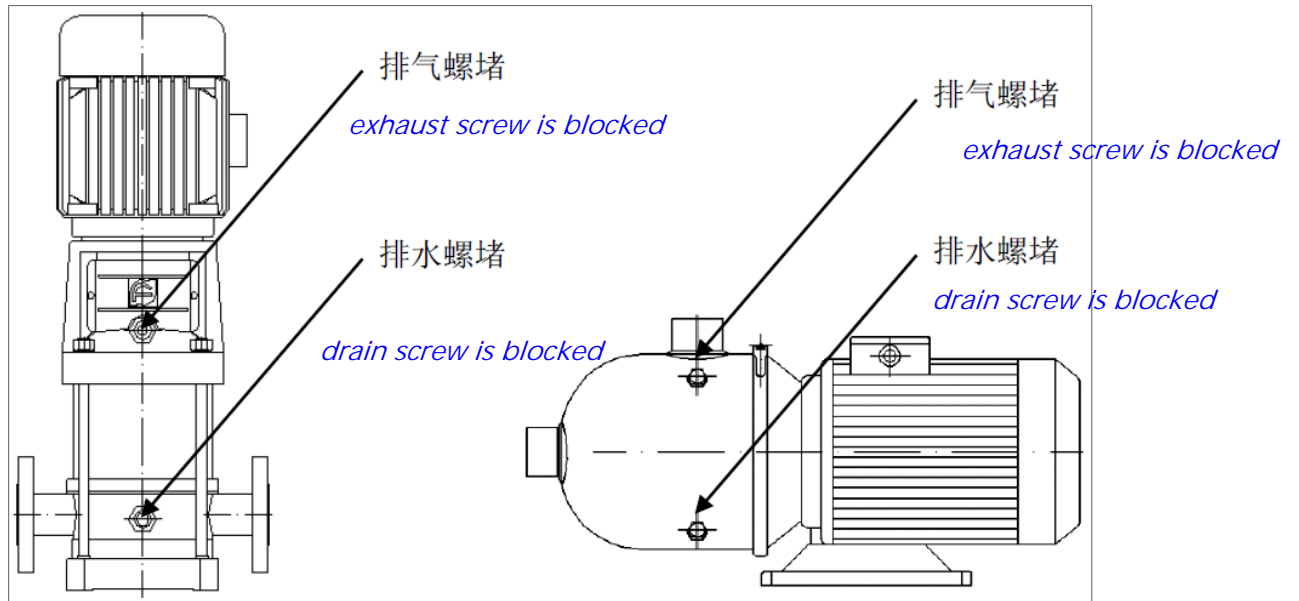

Fig 8 Pump exhaust and drainage

## 6.5 warm prompt

After the electric water pump on the equipment runs for a period of time, continue to fill the water tank to the standard area of the liquid level.

## 7 Products use

### 7.1 Check before commissioning

- Check whether the water inlet and outlet ball valves are open and the drain valve is closed;
- Check whether the water connection is correct, whether it is loose, and there must be no bubbling and water leakage;
- Check whether the liquid level of the water tank is in the standard area;
- Check whether the power source conforms to the product nameplate, the 380V power cord is a three-phase five-wire system, and the 220V power cord is a single-phase three-wire system;
- Check whether the equipment is grounded;
- Check that the electrical wiring between the equipment is properly connected.
- 
- 

### 7.2 Controller panel introduction

At present, there are three kinds of controllers for Hanli fiber laser chillers. Most models use split digital tube controllers, as shown in Figure 9. The dual 8-display integrated digital tube controller used by a small number of models in the early stage is shown in Figure 10. Shown.

7.2.1



Digital Tube	Usage
Display window	Display measured temperature (Low temp water L.xx.x/Room Temp water H.xx.x)、set temperature display (Low temp water S.xx.x/Room temp water temp difference d.xx.x)、Alarm code (Exx)、parameter code (Fxx)。
Indicator light	Usage
Compressor	On: the compressor is working; flashing: there is a cooling demand. Off: the compressor is off.
Low temp water heating (Heating1)	On: Low-temperature water heating is working; Off: Low-temperature water heating is off.
Room temp water heating (Heating2)	On: room temperature water heating work; off: room temperature water heating off.
Failure Indication	Flashing: There is a fault; Off: No fault
Button	Usage
On/Off button	Press < On/Off > button for 3 seconds for turning on or off
Set button	In the non-fault state, press the <Set> button to enter/exit the set temp
Up/down button (▲ ▼)	During the parameter setting process, modify the parameter value.

7.2.2 Introduction of the integrated controller panel

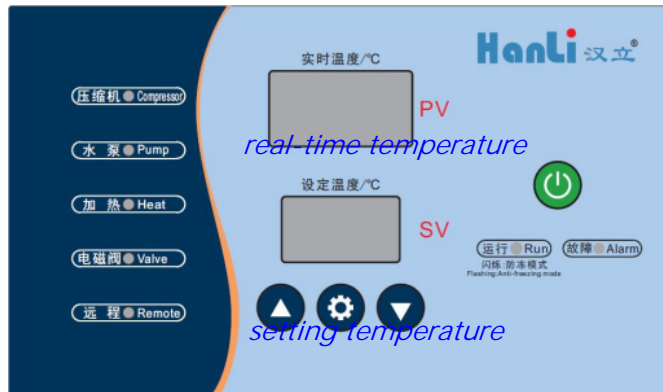

Fig. 10 integrated controller panel

Digital Tube	Usage
Real-time temp (PV)	Display "actual measured water temperature/ alarm code" 。
Setting temp (SV)	Display "setting temperature" 。
Indicator light	Usage
Compressor	On: the compressor is on; flashing: there is a demand for refrigeration but the compressor has not been turned on. Off: the compressor is off.
Pump	On: the pump is on; off: the pump is off.
Heating (Heat)	On: heating is on; off: heating is off. Switch to the low temperature water interface to indicate low temperature water heating, switch to the normal temperature water interface to indicate normal temperature water heating
electromagnetic valve (Valve)	No effect
Remote	On: the remote switch is closed; off: the remote switch is off.
Run	On: The machine is working; Flashing: The machine is in antifreeze mode.
Failure indication (Alarm)	Off: The machine is shut down.
Flashing: There is a fault; Off: No fault	
Button	Usage
On/Off button	Press < On/Off > button for 3 seconds for turning on or off
Set button	In the non-fault state, press the <Set> button to enter/exit the set temp
Up/down button (▲ ▼)	During the parameter setting process, modify the parameter value.



### 7.2.3 Introduction of the split controller panel



Digital tube	usage
Display window	Display measured temperature (Low temp water L.xx.x/Room Temp water H.xx.x) 、 set temperature display (Low temp water S.xx.x/Room temp water temp difference d.xx.x) 、 Alarm code (Exx) 、 参数代码 (Fxx) 。
Indicator light	Usage
Run	On: the machine is working ; Off: The machine is stopped.
Failure indication (Alarm)	Flashing: There is a fault; Off: No fault
Button	Usage
Up button (▲)	Set parameters, fault reset
Down button (▼)	Switch display

## 7.3 starting up display

After the integrated controller device is powered on, the PV and SV areas will display the software version information, and enter the temperature display state after about 7 seconds

After the split controller device is powered on, the display window will display the software version information (Fxx/v100/A00), and it will enter the temperature display state after about 7 seconds.

## 7.4 Temperature display

### 7.4.1 Integrated controller temperature display

PV area shows "actual temperature", SV area shows "set temperature".

Low temperature water interface: PV area and SV area digital tube represent the display of low temperature water temperature and low temperature water setting temperature.

Normal temperature water interface: PV shows real time value, SV shows H{followed by F01 normal temperature water difference}, such as H3.0

Press <Down>button to switch between the normal temperature water and low temperature water interface, press <Up> button or 30s without operation to automatically switch back to the low temperature water interface.

## 7.4.2 Split controller temperature display

Display window default display of low temperature water temperature measurement (L.XX.X)

When the temperature is displayed, press the <▼> key to switch the display of room temperature water measurement water temperature (H.xx.x), low temperature water set water temperature (S.xx.x), and room temperature water set temperature difference (d.xx.x). , 30s no switching operation will automatically return to the low temperature water interface.

[Note] : L./H./S./ D. is the temperature code, and XX.X is the temperature value.

## 7.5 parameter setting

### 7.5.1 Integrated controller parameter setting

In the non-fault state, the SV set temperature will flash after pressing the <Set> key. At this time, the low temperature water set temperature can be modified by pressing the <Up> or <Down> key.

(When the low temperature water interface is the low temperature water setting temperature, when the normal temperature water interface is [F01 normal temperature water temperature difference] and the main interface cannot be modified), press the <Set> key to save the set value and exit the setting state after the setting is completed. (If there is no key operation for 5 seconds during the setting process, the system will automatically save the set value and exit the setting state).

Normal temperature water set temperature = [low temperature water set temperature] + [F01 normal temperature water temperature difference], to change the normal temperature water set temperature, you need to modify [F01 normal temperature water temperature difference].

Press the <Up>+<Down> key for 5 seconds to enter the factory parameter setting state. The factory setting parameters are generally not adjusted. If you need to adjust, please seek the consent of the chiller manufacturer.

### 7.5.2 Parameter setting of split controller

In the non-fault state, press the <▲>+<▼> keys at the same time to enter the low temperature water set temperature setting interface, set the temperature

xx.x is displayed flashing, and the set temperature can be modified by pressing the <▲> or <▼> key at this time.

If there is no key operation for 5 seconds after the setting is completed, the system will automatically save the setting value and exit the setting state.

Normal temperature water set temperature = [low temperature water set temperature] + [F01 normal temperature water temperature difference], change the factory parameter [F01 normal temperature water temperature difference]

In the temperature display interface, press the <▲>+<▼> keys at the same time for 5 seconds to enter the factory parameter setting state. The factory setting parameters are generally not adjusted. If you need to adjust, please ask the chiller manufacturer for consent.

In the process of selecting the manufacturer's parameters, press <▼> for parameter selection, press <▲> to enter parameter setting, no button operation after 15s exit the manufacturer's parameter setting (display window displays parameter items).

When setting the parameters, you can modify the parameter value through <▲> or <▼>. After 5 seconds of no key operation, or press the <▲>+<▼> key to return to the parameter selection and save (the display window flashes to display the parameter value)

## 8 maintaining

For maintenance, equipment must be shut down, cut off the power supply, and can only be operated after 3 minutes, otherwise there will be a risk of electric shock. When the ambient temperature is lower than 2° C, the internal water must be drained when the machine is shut down for a long time.

### 8.1 Dust prevention in summer

In summer, please clean the condenser and dust filter of the equipment about 15 days, as shown in Figure 11.

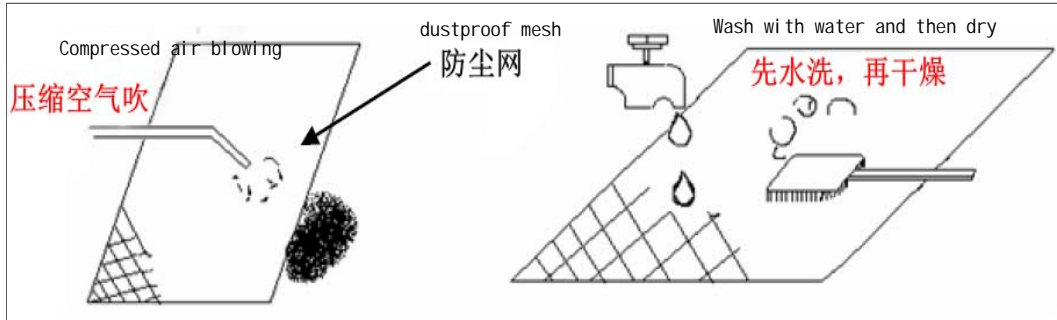

Figure 11 Cleaning and dust removal process of the dust screen

### 8.2 Winter antifreeze

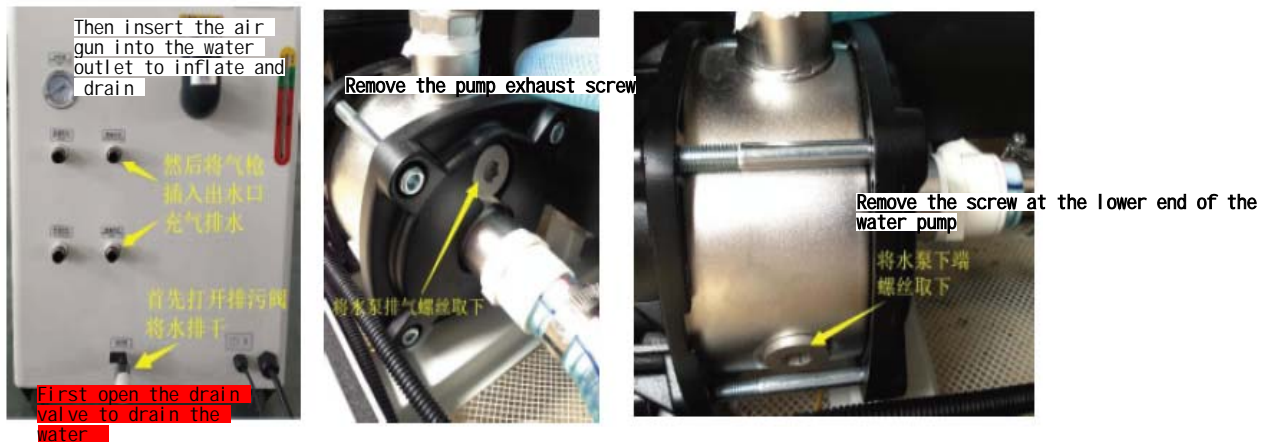

Figure 12 Winter anti-freezing maintenance

When the equipment is being transported or not in use for a long time, the water in the water tank should be drained through the drain valve, and the drain screw under the water pump should be loosened to drain the remaining water in the water pump, as shown in Figure 12.

If the ambient temperature at night is lower than 2° C, it is recommended that the customer does not stop the machine or add antifreeze. The volume ratio of ethylene glycol is selected according to Table 1. The preventing freezing point is equal to the ambient temperature of the equipment minus about 5° C. When the average daily temperature is higher than 5° C, replace the water containing antifreeze with softened water.

Table 1 Correspondence between different volume ratios of ethylene glycol and freezing point

volume ratio/%	freezing point /°C	volume ratio/%	freezing point /°C	volume ratio/%	freezing point /°C
1.8	-0.6	26.0	-13.0	51.9	-41.0
3.6	-1.3	28.0	-15.0	53.9	-44.0
5.4	-2.0	29.9	-17.0	56.0	-48.0
7.2	-2.7	31.9	-18.0	78.9	-47.0
9.1	-3.5	33.8	-20.0	81.0	-43.0
10.9	-4.4	35.8	-22.0	83.1	-40.0
12.8	-5.3	37.8	-24.0	85.2	-36.0
14.6	-6.3	39.8	-26.0	87.3	-33.0
16.5	-7.3	41.8	-28.0	89.4	-29.0
18.4	-8.0	43.8	-31.0	91.5	-26.0
20.3	-9.0	45.8	-33.0	93.6	-23.0
22.2	-11.0	47.8	-36.0	95.8	-19.0
24.1	-12.0	49.8	-38.0	100	-13.0

## 8.3 Daily maintenance

The working scene of the fiber laser chiller is very bad. In order to ensure the good performance of the equipment and extend the service life of the equipment, the equipment needs to be maintained. The frequency of maintenance is once a week. The maintenance work includes but is not limited to the following aspects of work

- Check the condenser, check whether the air duct is blocked by foreign matter, and whether the air inlet and outlet around the equipment is smooth;
- Clean the condenser and clean the dust-proof net;
- Check the cooling medium for foreign matter, whether it breeds microorganisms, etc. Generally, replace the cooling medium within 15-20 days. The cooling medium must be pure water, distilled water or high-purity water;
- Check whether the water connection is loose and whether the water pump is leaking;
- Check the water tank and clean up the dirt deposited inside the water tank;
- Clean the filter in the water circuit of the equipment regularly. Generally, the filter is cleaned once every 7-10 days. The two types of filters commonly used by our company are shown in Figure 13. The Y-type filter is installed at the water pump suction or the equipment outlet with a built-in stainless steel filter. The device is placed in the water tank;

- Test insulation resistance, insulation resistance  $\geq 5M\Omega$ ;
- Check the ground resistance, ground resistance  $\leq 4\Omega$ ;
- Carry out the capacitance value test on the capacitors of the compressor and the fan, and the capacitance value attenuation exceeds 10%, and the capacitor needs to be replaced.

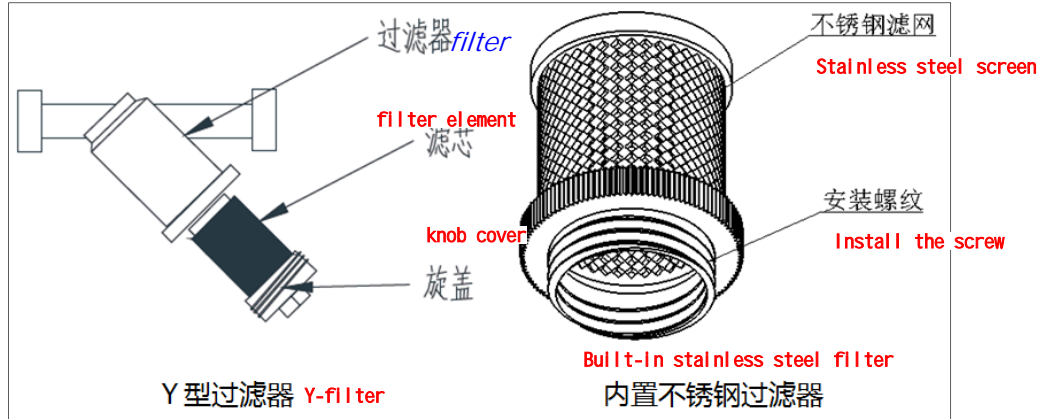

Figure 13 Two kinds of filters commonly used by our company

## 9 Failure analysis and elimination

When the machine detects a fault, the display area alternately displays the temperature and the fault code "Exx". If there are multiple faults, you can press <Up> or <Down> to switch to view different faults. After pressing the <Up> or <Down> key, the fault code will be displayed fixedly, and the temperature and fault code will be displayed alternately after 5s. The fault codes and descriptions are as follows:

fault code	fault name	fault analysis	action	elimination methods
E01	low temperature water probe fault	A: Low temperature water probe short circuit/disconnection B: Low temperature water probe is damaged	Non-stop water pump, all other outputs are stopped	A: Check whether the probe wire is loose B: change the probe
E02	low temperature water High temperature alarm	A: Insufficient water flow B: Poor ventilation C: Too much dust	Only stop low temperature hydroelectric heating	A: Detect water supply pipeline B: Clean up the surrounding debris C: Clean the dust from the condenser
E03	compressor Pressure failure	A: Poor ventilation B: Refrigerant leak C: The condensing fan is not running D: Too much dust on the filter E: Damaged pressure switch	Stop the compressor, keep the water pump	A: Clean up the surrounding debris B: Check leakage C: Check the fan D: clean the dust E: Check whether the pressure switch and wiring are loose
E04	Phase sequence alarm	A: Power phase loss/phase loss B: Phase sequence error C: Three-phase unbalance B: Damaged phase sequence protector	Stop the machine	A: Check power supply B: Arbitrarily swap two phase wires C: Check the power supply circuit D: Replace the phase sequence protector
E05	low temperature water flow alarm	A: The low temperature water pipeline is blocked B: Reverse connection of inlet and outlet C: Water leakage in the suction pipe D: The flow switch is damaged	not stop water pump, all others are outputed and then stop it	A: Clean the pipeline B: Check the water inlet and outlet pipelines C: Check and tighten the suction pipe D: Check the flow switch and replace

E06	Water level switch alarm	A: Insufficient water tank level	Stop low temperature water and	A: Water replenishment (to the standard area of the liquid level)
E07	Compressor overload	A: The condenser is dirty and blocked B: Fluoride leakage C: Blocked air inlet and outlet D: The ambient temperature is too high	Stop the compressor	A: Clean up the dust B: Check for leaks C: Clean up debris around the equipment D: Place the equipment in a well-ventilated place
E08	Low temperature water Low temperature alarm	A: The temperature of the water outlet of the equipment is too low	Stop the compressor, keep the water pump running	A: Check if the relay is stuck
E09	normal temperature water probe fault	A: Short circuit/disconnection of water probe at room temperature B: Normal temperature water probe is damaged	not stop water pump, all others are outputed and then stop it	A: Test probe terminal and connection B: Replace the probe
E10	normal temperature water high temperature alarm	A: Insufficient water flow B: Poor ventilation	Only stop normal temperature hydroelectric heating	A: Check whether there is backwater at normal temperature and whether the B: Clean up the surrounding debris
E11	normal temperature water low temperature alarm	A: The temperature of the water outlet of the equipment is too low	Stop the compressor, keep the water pump	A: Check if the relay is stuck
E12	normal temperature water flow alarm	A: The normal temperature water pipeline is blocked B: Reverse connection of inlet and outlet C: Leakage in the normal temperature water pipeline D: The flow switch is damaged	Stop normal temperature hydroelectric heating	A: Check whether the cutting head has backwater B: Check the water inlet and outlet pipelines C: Check and tighten the water pipe joints D: Replace the Flow switch

[Remarks]: For faults that need to be reset manually, after the fault of the integrated controller is eliminated, the fault can be reset by pressing the <Set> key, and the remote controller can be reset by pressing <▲> for 3 seconds to reset the fault, and it will automatically start after the fault is eliminated.

## 10 Circuit diagram

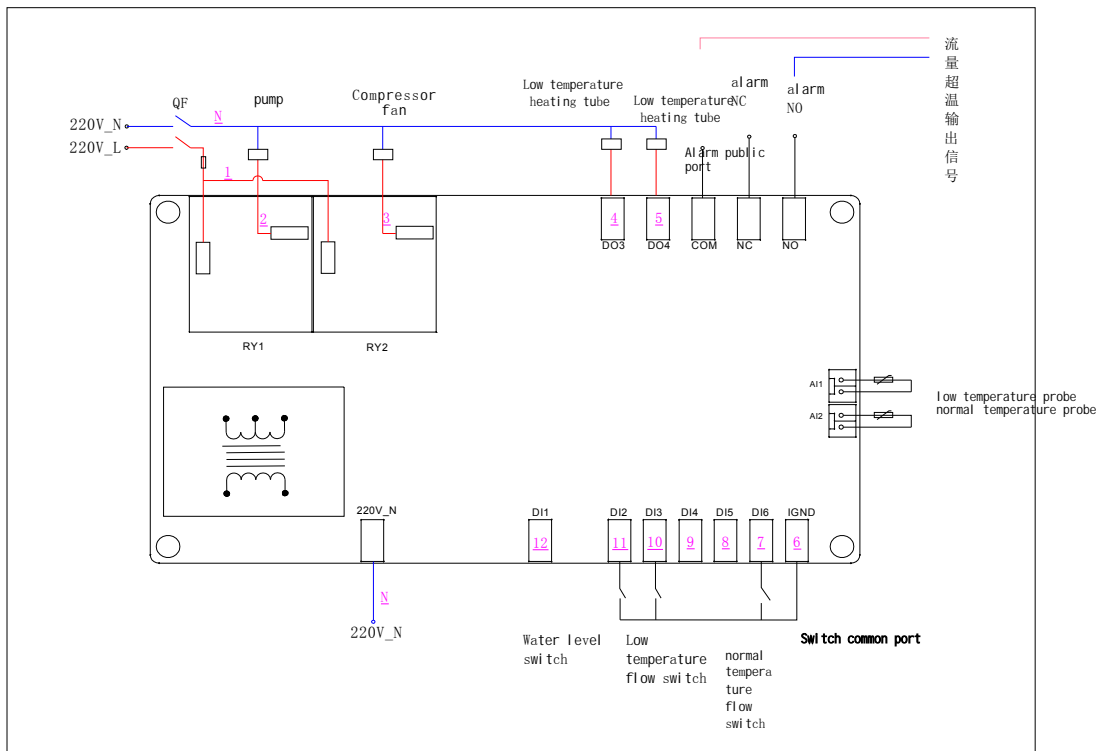

Figure 14 220V equipment circuit diagram

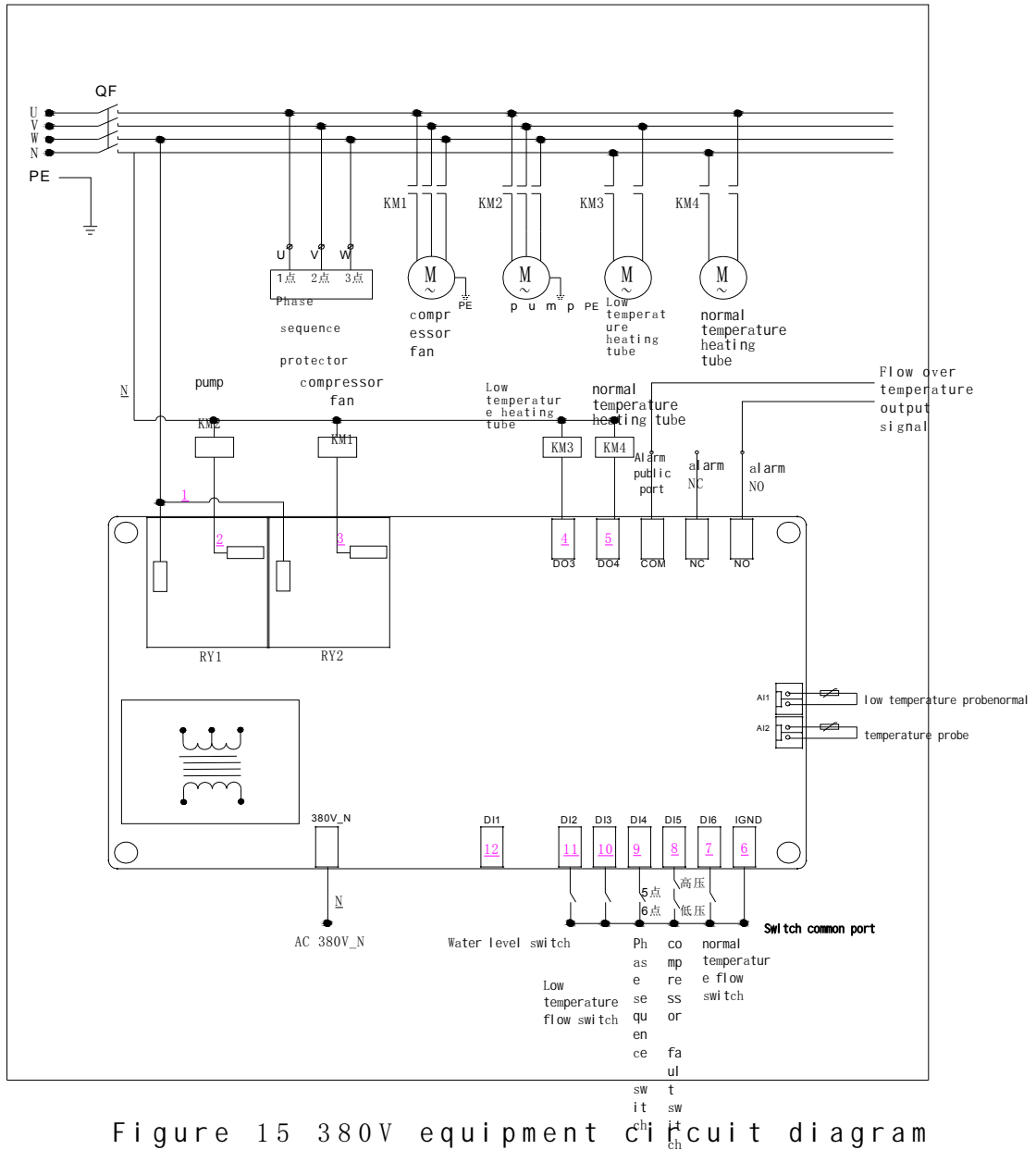

Figure 15 380V equipment circuit diagram

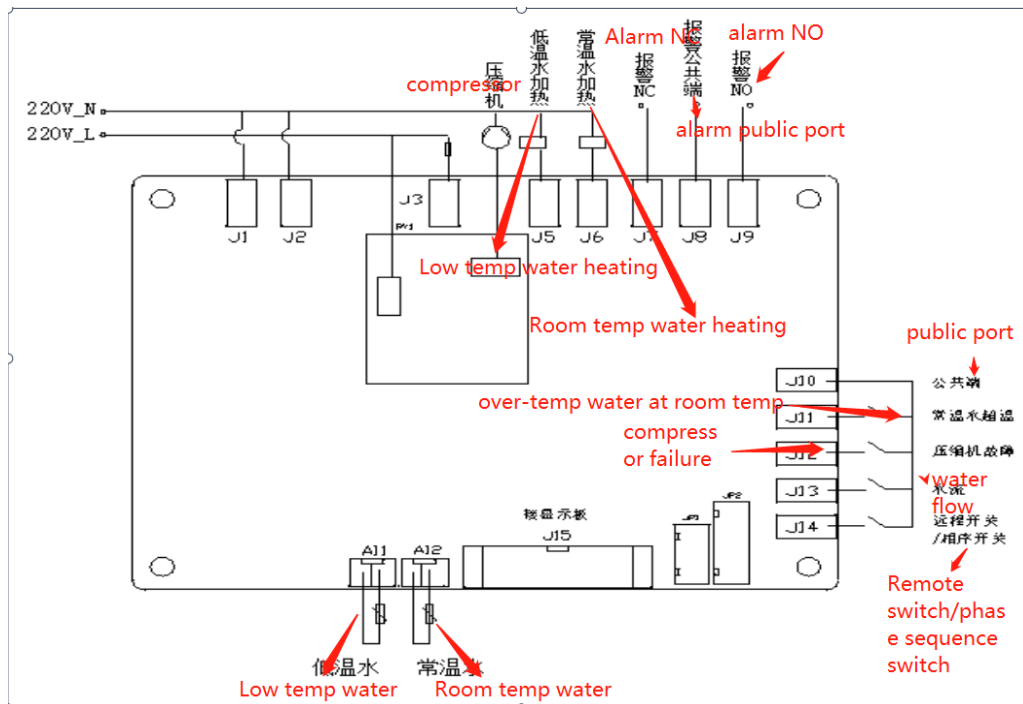

Figure 16 Split controller circuit diagram

## 11 Transport and storage

### 11.1 Transport requirements

1. When transporting or handling, please do not bump up and down or incline it excessively (no more than 45 °), avoid bumping, bumping and turning over.
2. When moving the equipment, please use the correct tools, such as a forklift or crane, and do not carry the equipment with your bare hands.
3. Before moving the device, please remove the power cord and drain the coolant inside the system. Do not move or transport the device with liquid.
4. When using a forklift to move the equipment, make sure that the equipment is in a stable state and the height is less than 200mm from the ground, and make sure to avoid the equipment casters.
5. When using a crane to move the equipment, the equipment needs to be steadily held with a wire rope before it can be moved. .

### 11.2 Storage requirements

When it is not used for a long time, please drain the coolant in the equipment, and use compressed air to drain the remaining coolant in the water pump, filter and pipeline, wipe off moisture and oil, and pack the equipment with stretch film to prevent Dust and waterproof, place it in a cool, ventilated, no direct sunlight, no dust gathering place, if it is a device with casters, lock the universal wheel.



Storage environment conditions, temperature: 0~60°C,  
relative humidity: ≤90%.

## 12 Other instructions

### 12.1 Service support

#### 12.1.1 Warranty

- Within 24 months from the date of purchase of the product by the company, if it is obviously a failure caused by a design defect or a quality problem caused by the manufacturing, the company provides free repairs and replacement parts. After the warranty period expires, paid maintenance for life.

#### 12.1.2 Cases not within the scope of the warranty

- Failure to install in accordance with the instructions, use and maintenance, or damage caused by external conditions such as power supply that do not meet the requirements during use.
- Damage caused by improper transportation and storage by our company.
- Modifications to our company's products or damage caused by other human factors.
- Damage caused by force majeure. Such as: natural disasters, wars, etc.
- Damage caused by installation on vehicles or ships or used abroad.
- Damage due to equipment failure
- 

#### 12.2 Other matters

- The power supply must be installed in accordance with the national wiring standards (voltage, frequency, and pressure difference must meet the requirements). If the power cord is damaged, in order to avoid danger, it must be replaced by professionals from the manufacturer's maintenance department or similar departments. During maintenance, the power must be turned off for 3 minutes before the maintenance can be carried out.